



Simulated collision risk of uncoordinated airborne self separation

by

Henk Blom

e-mail: blom@nlr.nl



Airborne Self Separation in Air Transportation
ICRAT Tutorial, Budapest, Hungary, 1st June 2010



Simulated collision risk of uncoordinated airborne self separation



- Motivation
- AMFF (Autonomous Mediterranean Free Flight)
- MC simulation modelling
- MC simulation results
- Conclusions





Motivation



- Free Flight has been “invented” as a potential solution for high density airspace
- During recent years ATM community research trend is to direct self separation research to situations of less dense airspace (e.g. MFF, ASSTAR)
- Key question: up to which en-route traffic density is safe free flight feasible?





Simulated collision risk of uncoordinated airborne self separation

- Motivation
- AMFF (Autonomous Mediterranean Free Flight)
- MC simulation modelling
- MC simulation results
- Conclusions





Autonomous Mediterranean Free Flight (AMFF)



- Future concept developed for traffic over Mediterranean area
- Aircrew gets freedom to select path and speed
- In return aircrew is responsible for self-separation
- Each a/c equipped with ASAS (Airborne Separation Assistance System)
- Conflicts are solved one by one (pilot preference)



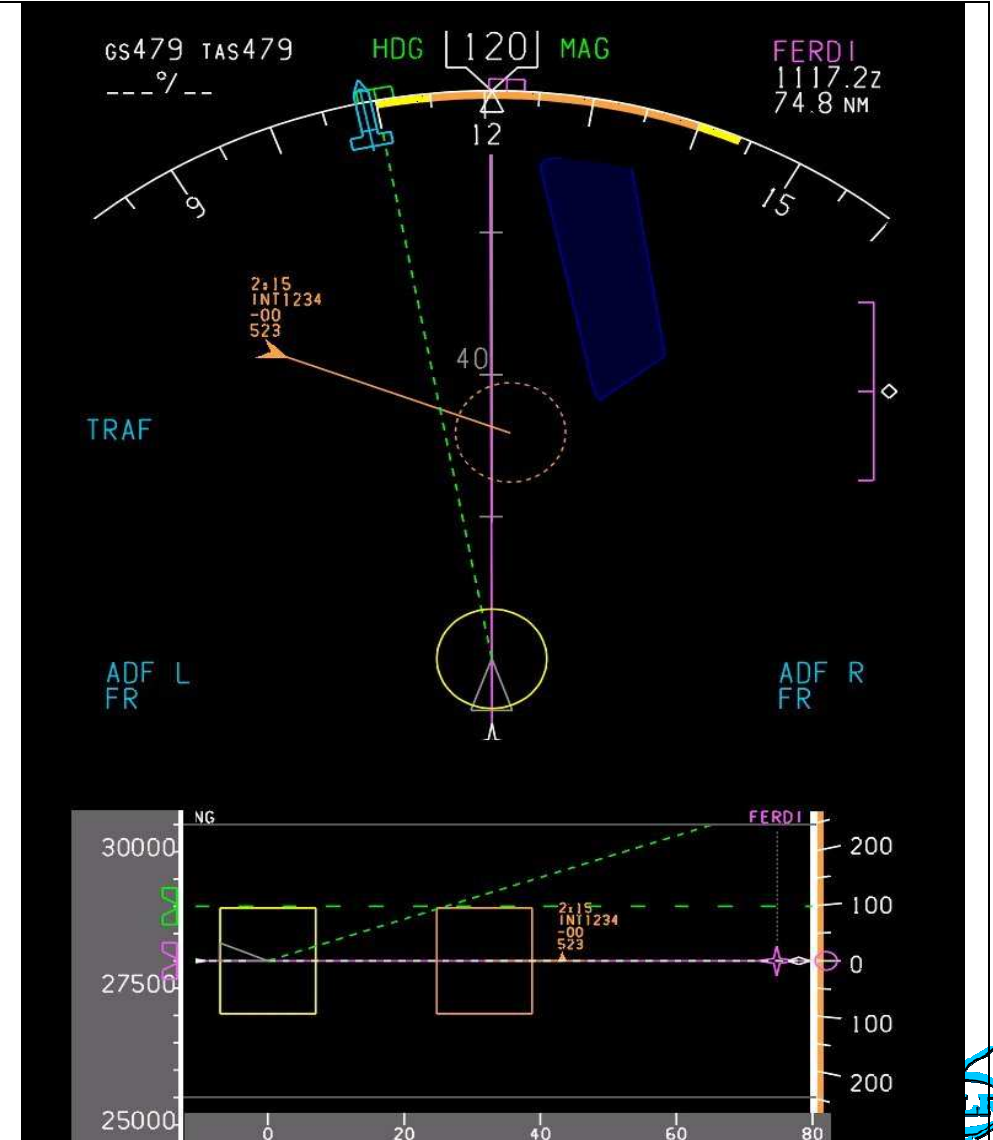
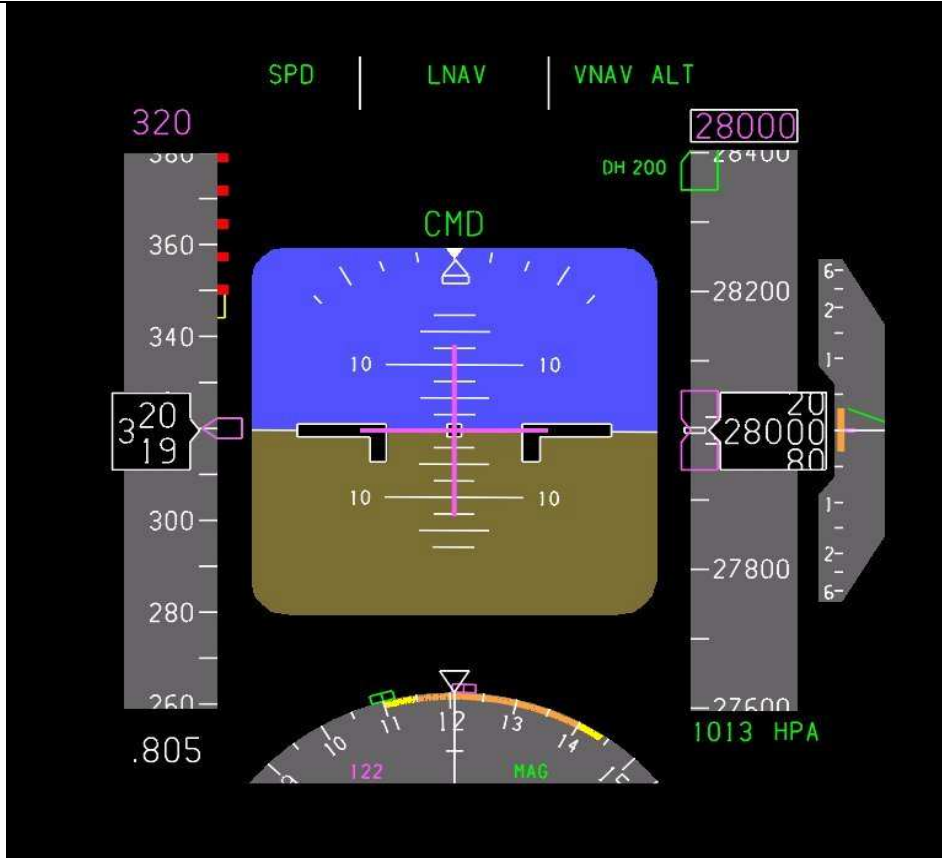



Evaluations performed by MFF project

- Real-time pilot-in-the-loop simulations
- Eurocae/RTCA ED78a safety assessment

Can AMFF accommodate high traffic demand ?





Simulated collision risk of uncoordinated airborne self separation

- Motivation
- AMFF (Autonomous Mediterranean Free Flight)
- MC simulation modelling
- MC simulation results
- Conclusions





Systemic modelling and simulation using TOPAZ methodology



- Hazard identification
- Defining the relevant Agents
- Developing Petri net for each Agent
- Connecting Agent Petri nets
- Parametrization, Verification & Calibration
- Monte Carlo simulation
- Speeding up MC simulation
- Validation





Multi Agent model

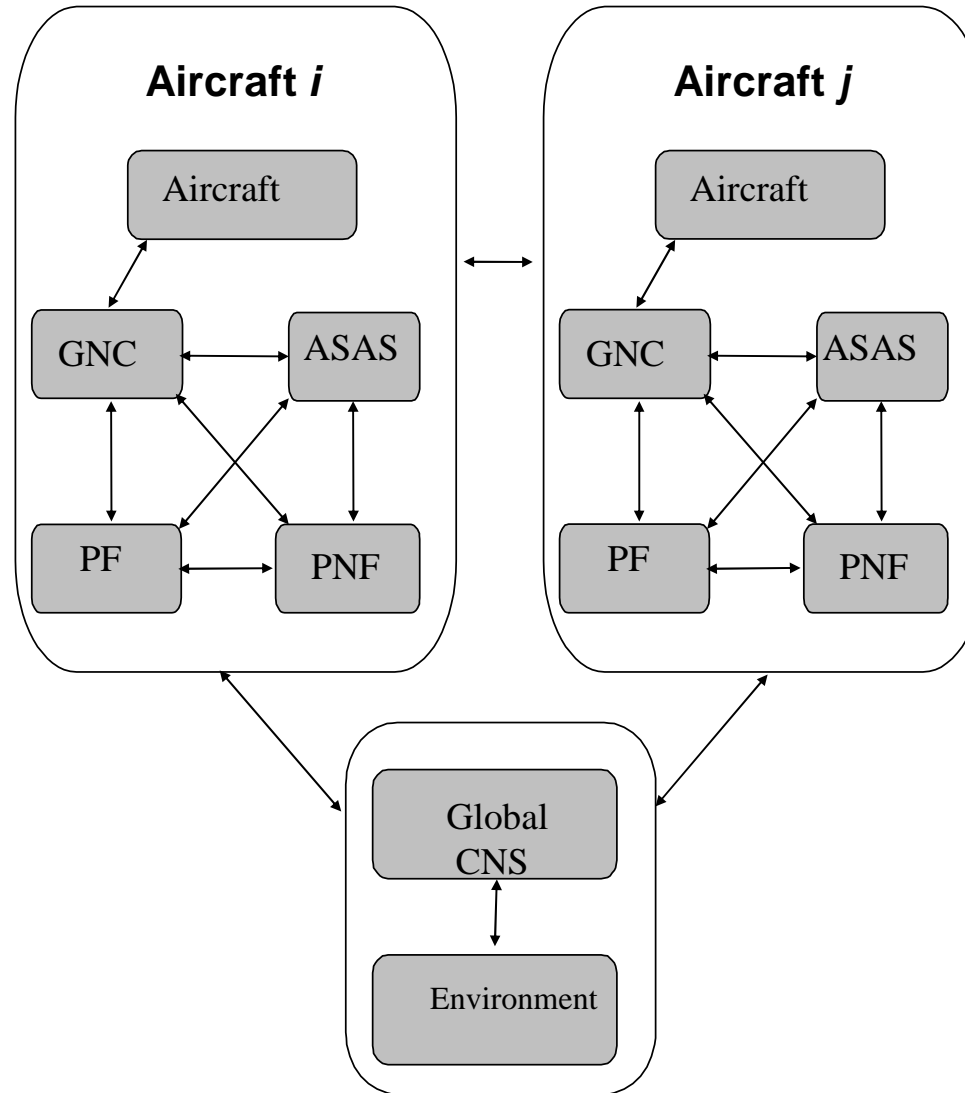



Eight aircraft encounter

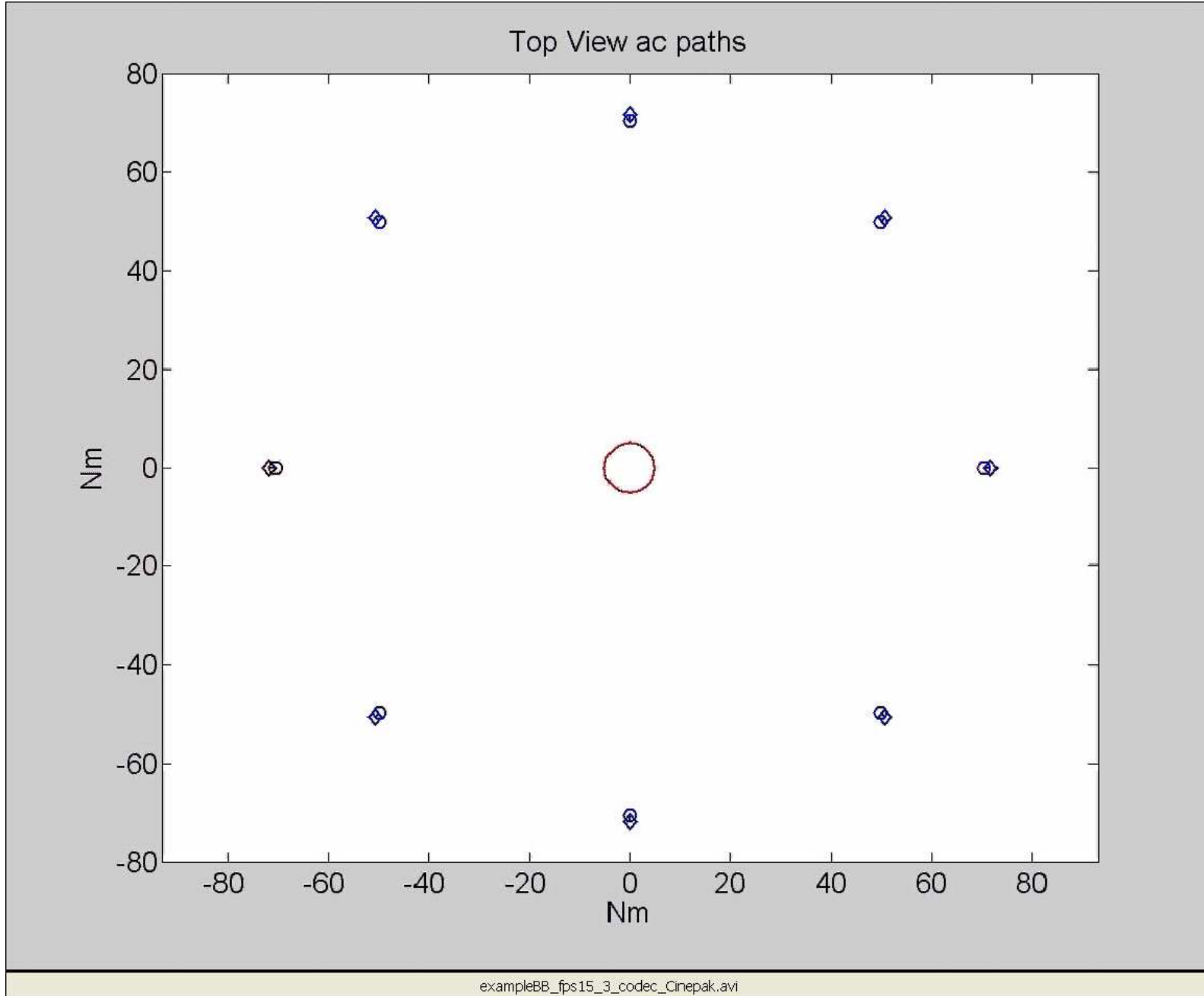

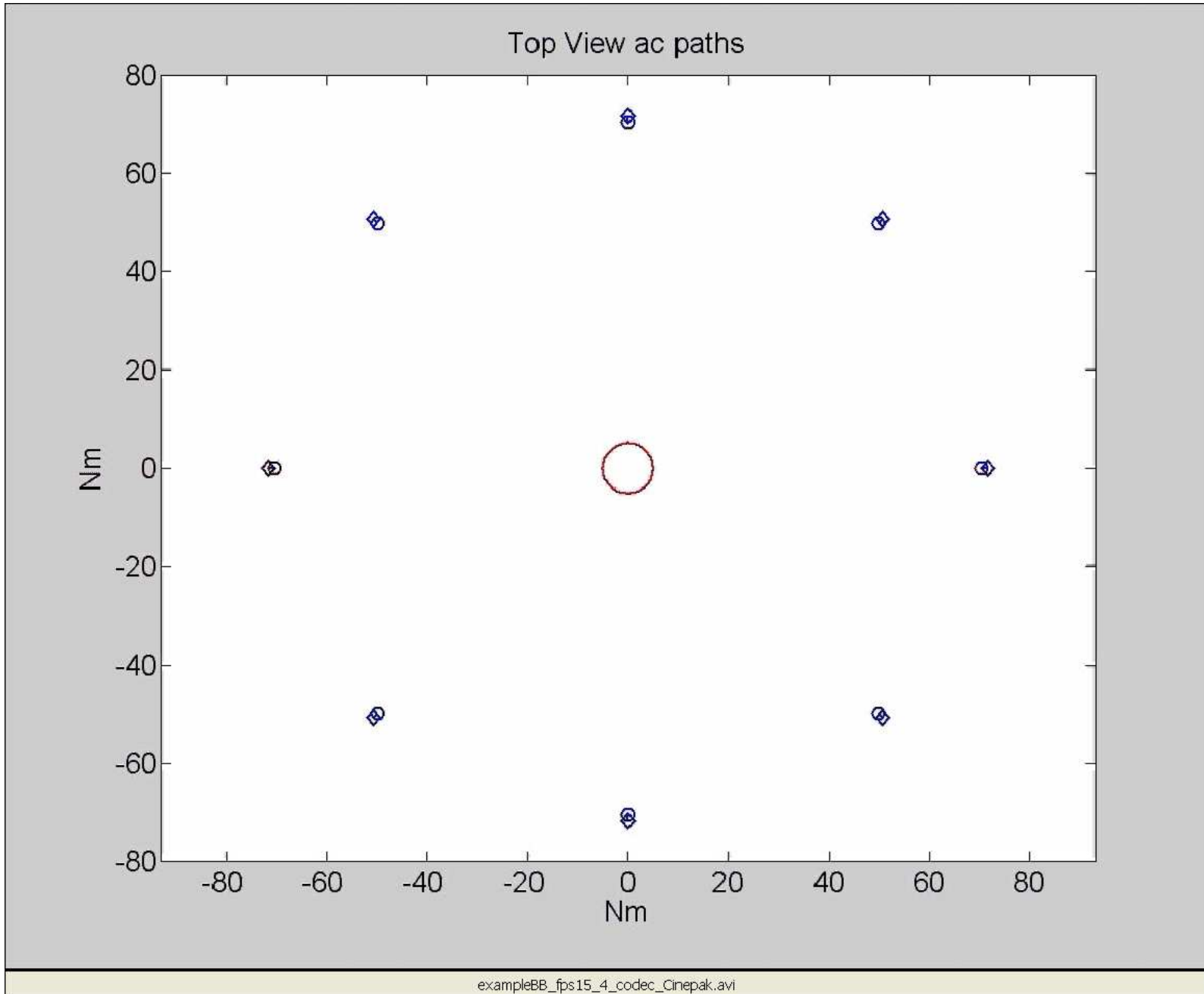

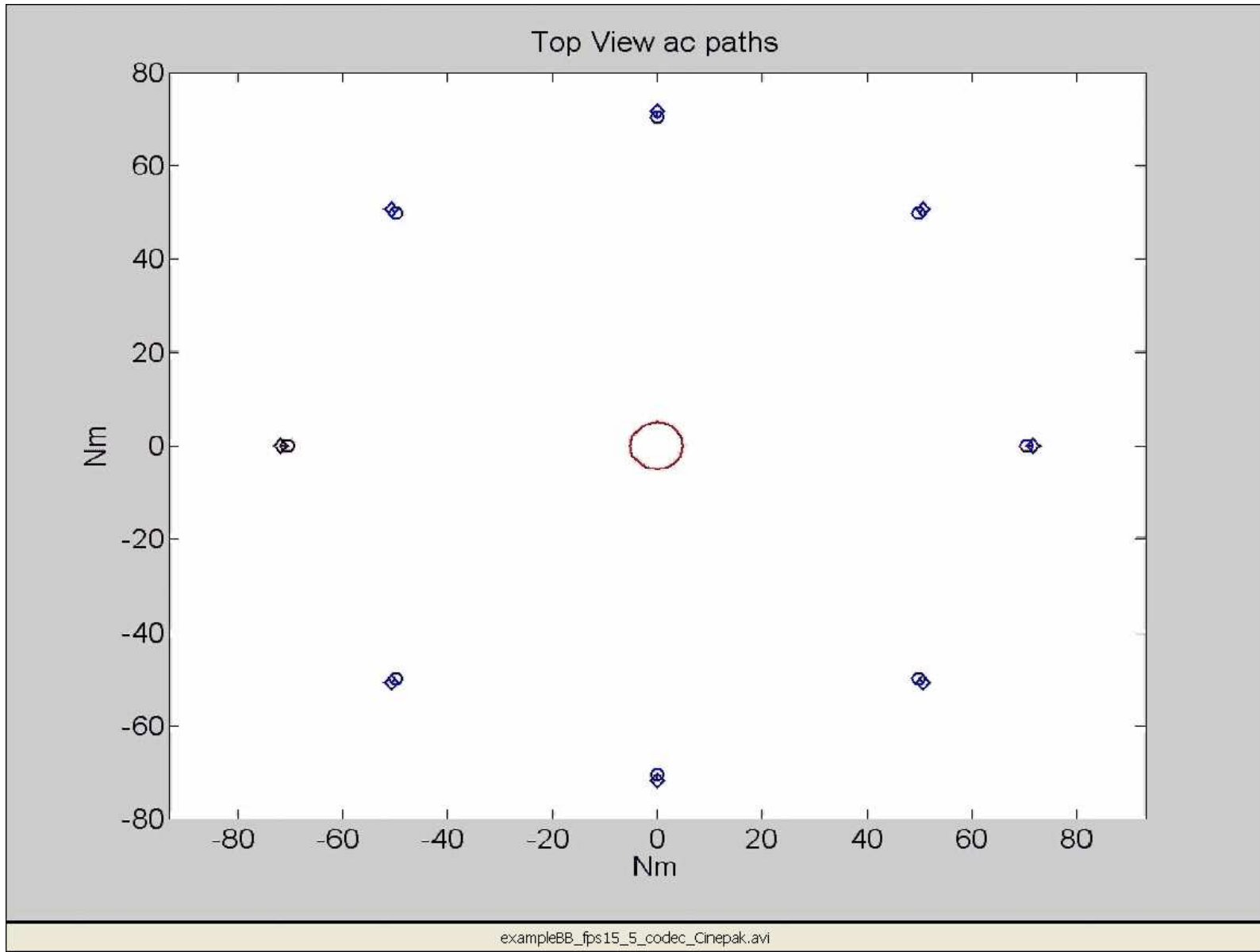



MC simulation speed up



- Simulate from one conflict level to conflict level
- A fraction of simulations reaches next level
- Multiply fractions of these simulations
- Conditions for convergence (Cerou et al., 2002)

Conflict levels in air traffic

MTC = Medium Term Conflict

STC = Short Term Conflict

MSI = Minimum Separation Infringement

NMAC = Near Mid-Air Collision

MAC = Mid-Air Collision





Simulated collision risk of uncoordinated airborne self separation

- Motivation
- AMFF (Autonomous Mediterranean Free Flight)
- MC simulation modelling
- MC simulation results
- Conclusions





Scenarios

- Two aircraft encounter
- Eight aircraft encounter
- Random traffic high density





Two-aircraft head-on encounter

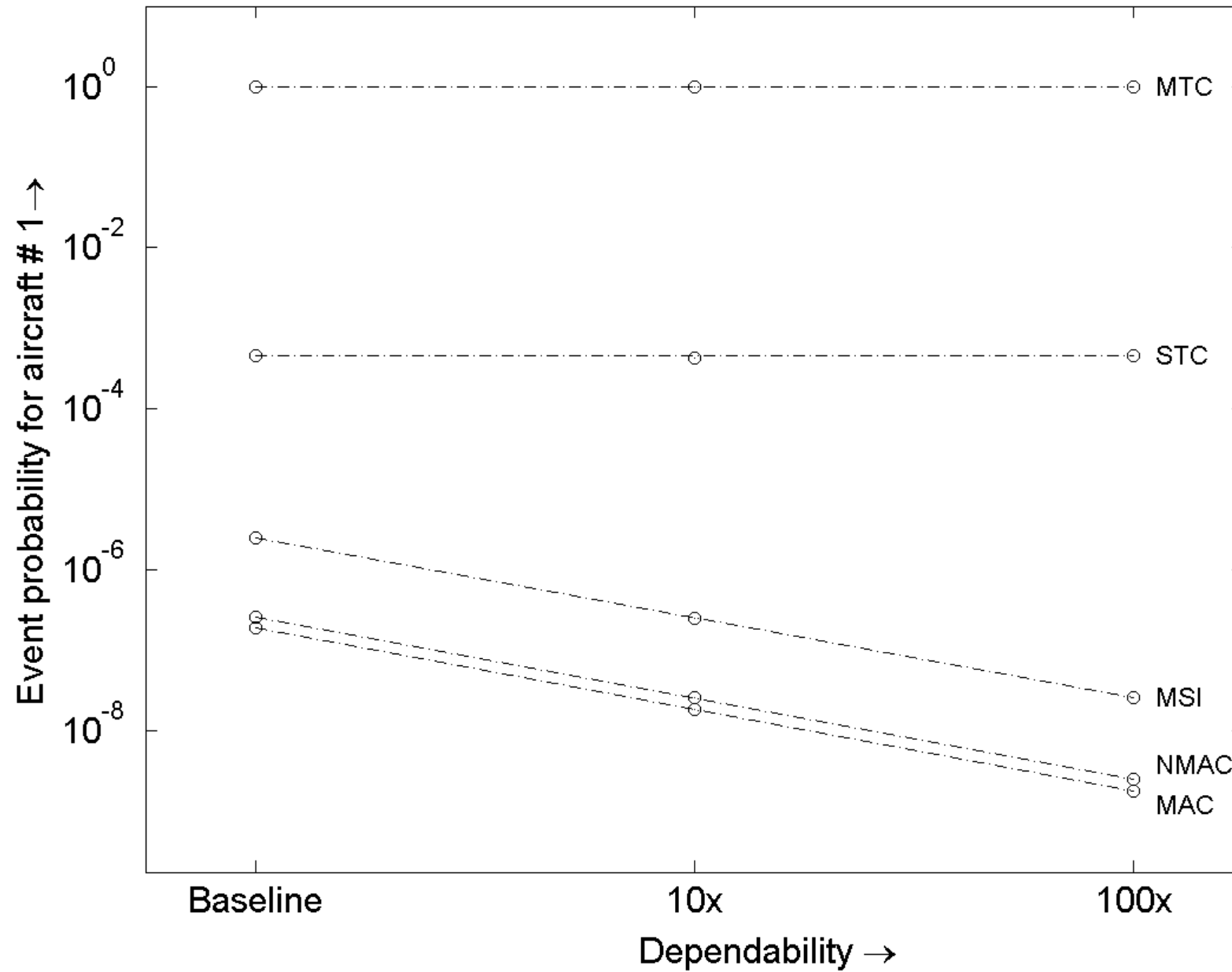



Two-aircraft vs. eight-aircraft encounter.

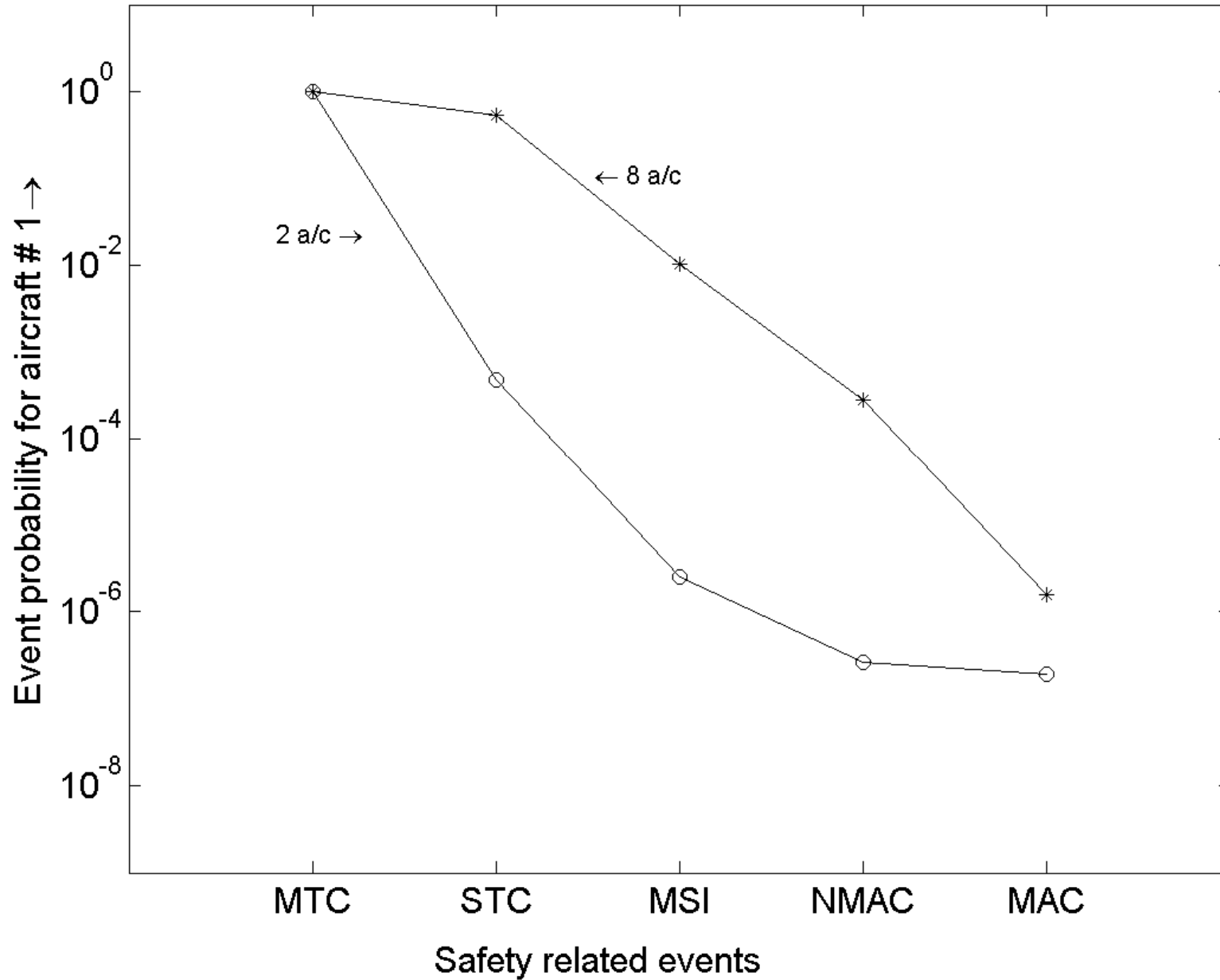



Eight-aircraft encounter: Baseline PF response vs. Fast PF response

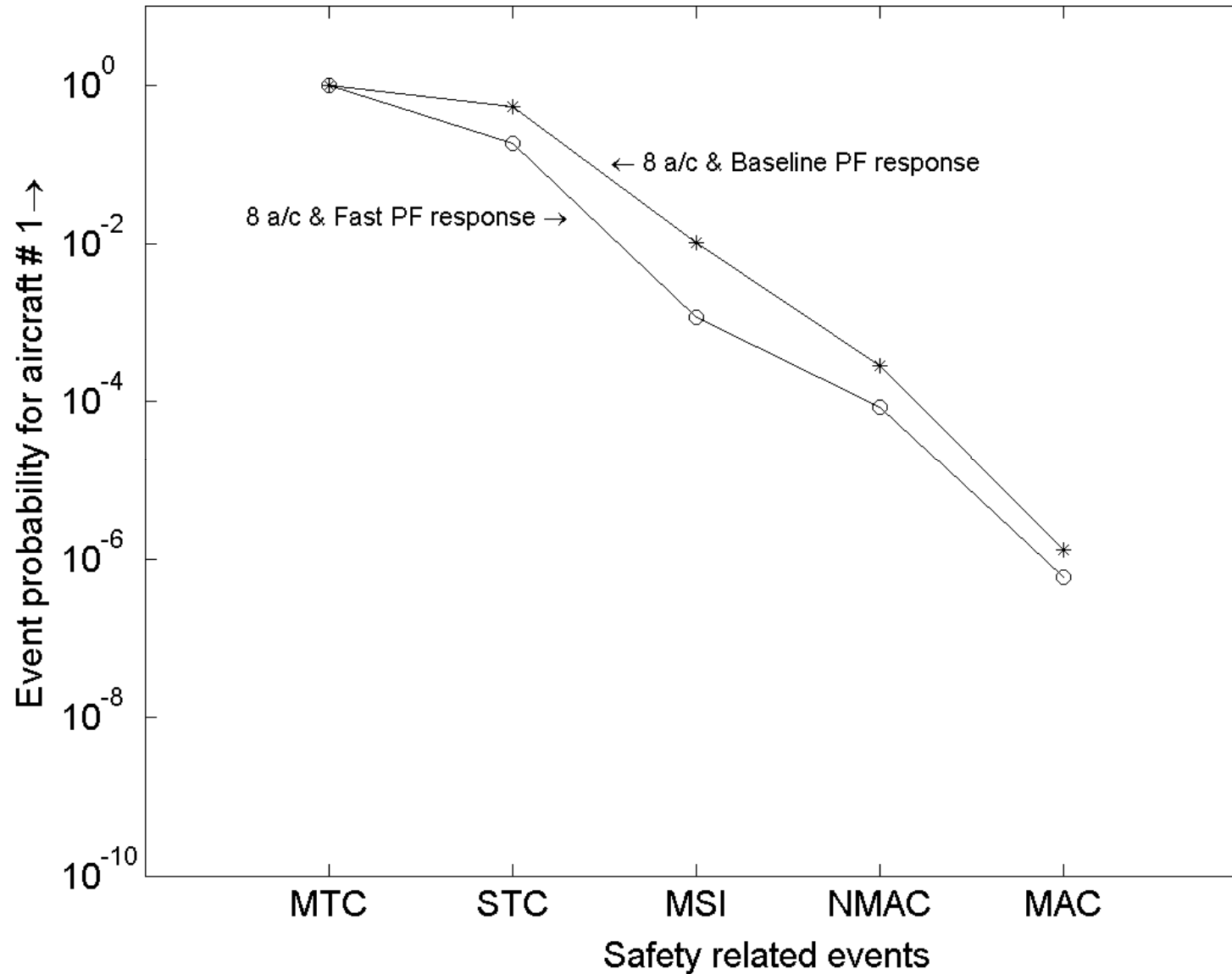



Random traffic, high density

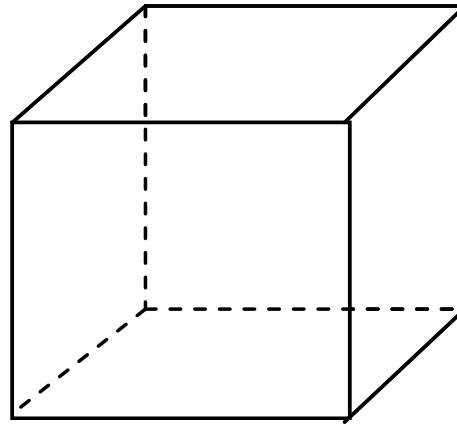

- **Eight aircraft per packed container**
 - 3 times as dense above Frankfurt on 23rd July '99





Random high traffic: Uncontrolled vs. AMFF controlled

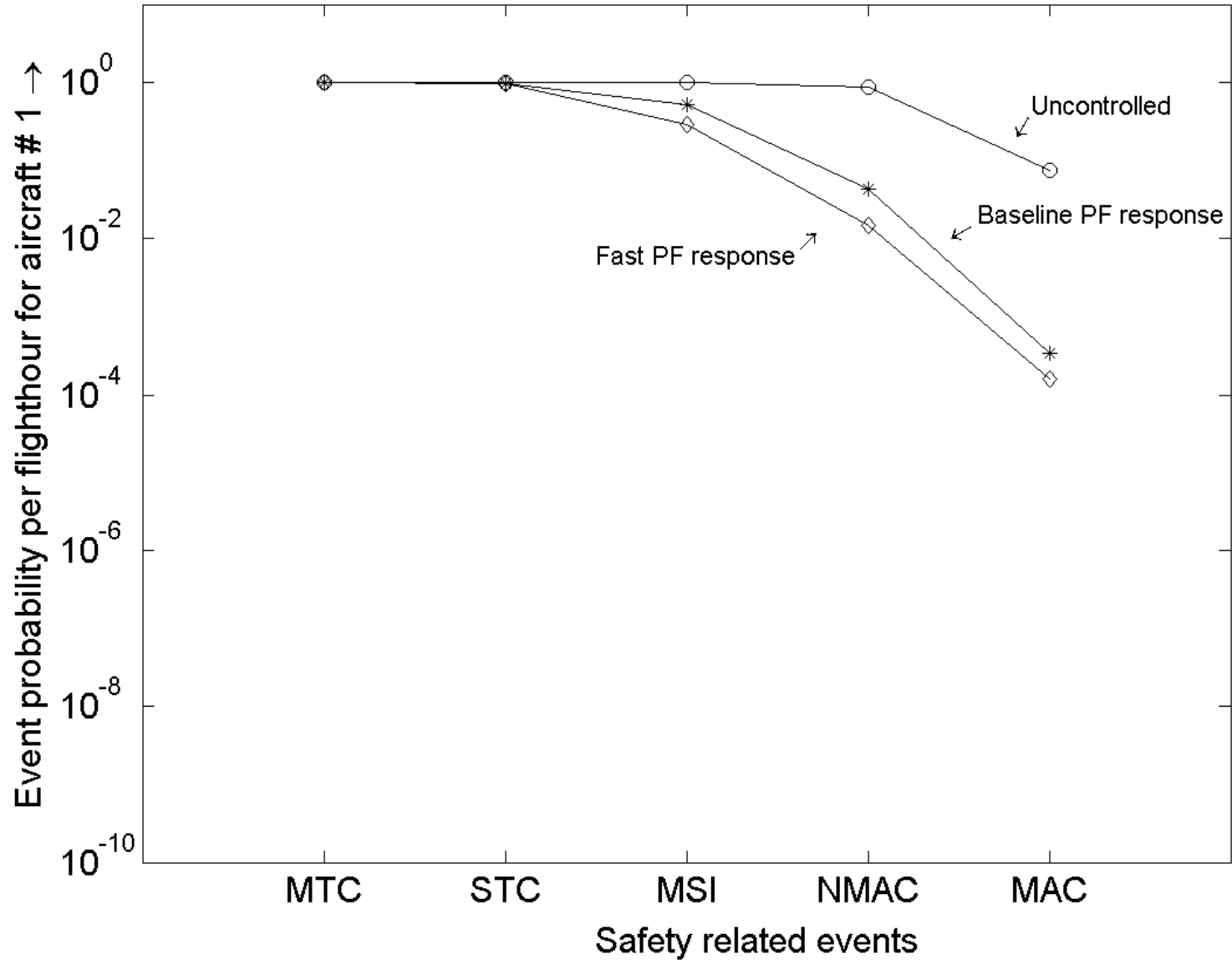

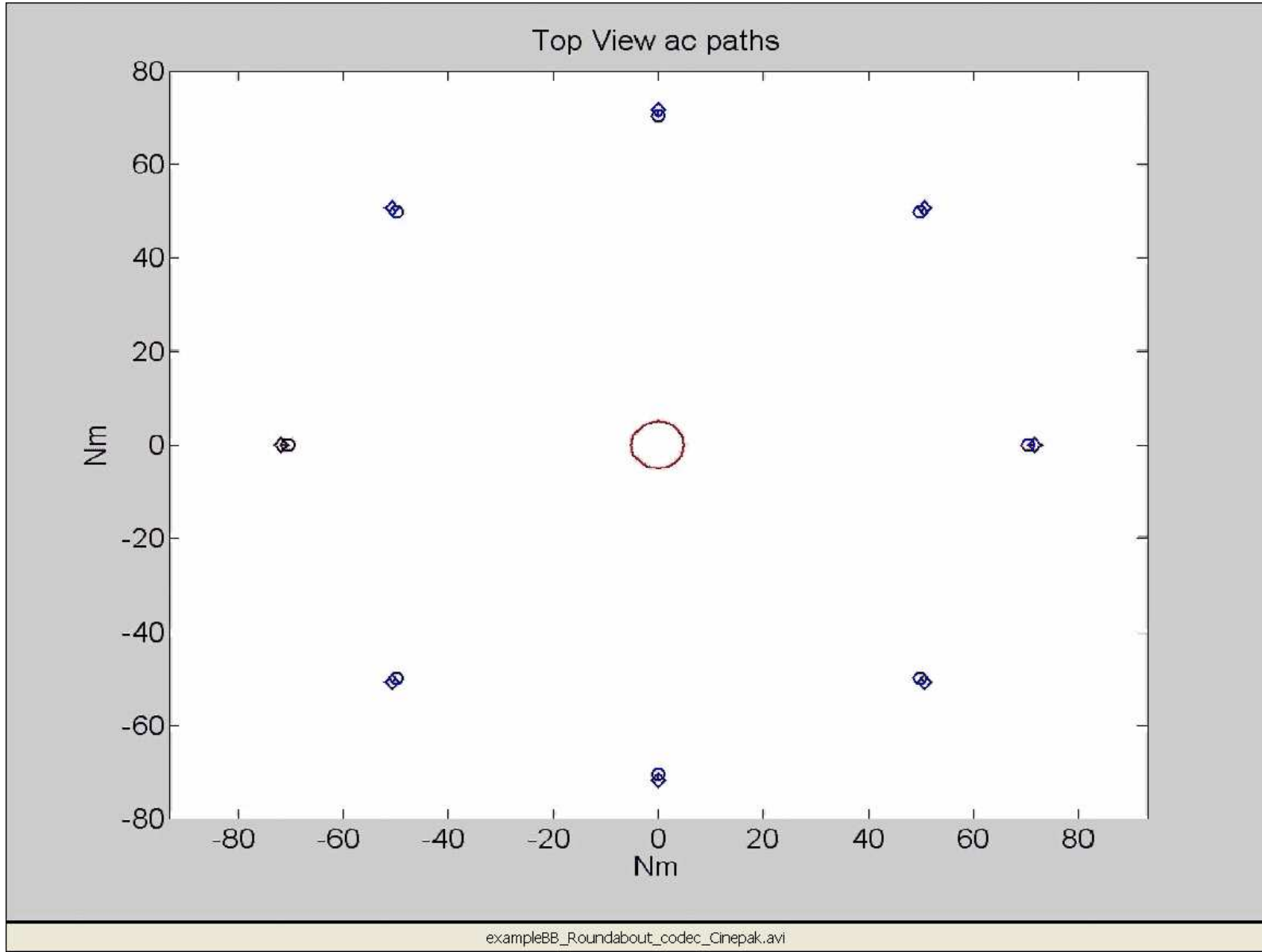



Simulated collision risk of uncoordinated airborne self separation

- Motivation
- AMFF (Autonomous Mediterranean Free Flight)
- MC simulation modelling
- MC simulation results
- Conclusions





Conclusions

- Uncoordinated conflict resolution falls short in safely accommodating high en route traffic demand
- Advanced airborne self separation might do much better
- Follow-up work on risk assessment:
 - Evaluate advanced airborne self separation concept
 - Include ACAS in simulation model
 - Further improve simulation speed-up
 - Validation of assessed risk level





To be continued

<http://iFly.nlr.nl>

